



Lojer Capre E1, E2 examination tables

Instruction for use

ID: DX012187, rev. 2 / 12.10.2023 (en)



Contents

1	Lojer Capre E tables	3
1.1	Intended purpose	3
1.2	User Groups	3
1.3	Contra-indications	3
1.4	Description of parts	4
1.5	Options and accessories	5
1.6	Symbols used on the device	5
2	Introduction	7
2.1	Inspection upon delivery	7
2.2	Before use	7
2.3	Leveling the table	7
2.4	Safety instructions	8
3	Using the device	9
3.1	Adjustment range	9
3.2	Central locking	9
3.3	Height adjustment	10
3.4	Back section	11
3.5	Options and accessories	12
3.5.1	Paper roll holder	12
3.5.2	Battery operation	12
3.5.3	IV-pole	12
4	Cleaning and disinfecting	13
4.1	Cleaning	13
4.1.1	Frame and other hard surfaces	14
4.1.2	Textile surfaces	14
4.2	Disinfecting	14
4.2.1	All surfaces	14
5	Maintenance	15
5.1	Biannual measures	15
5.2	Annual measures	15
5.3	Troubleshooting	16
5.4	Preventive maintenance	16
6	Technical information	18
6.1	Standards	18
6.2	Recycling	18
6.3	Circuit diagram	20
6.4	Electromagnetic compatibility (EMC)	21
6.4.1	Electromagnetic emission	21
6.4.2	Electromagnetic immunity	22
7	Limited International Warranty	24
8	Contact information	25



Read these instructions carefully. Follow all warnings and instructions marked on the product



This document is a translation of the original English version. In case of conflict, the original English version applies.

Lojer Group is leading producers of medical furniture and physiotherapy equipment in Nordic Countries. We design and manufacture medical and treatment furniture to be used by health care professionals in various operating environments. Lojer has committed to develop and manufacture these devices in a sustainable manner in order to provide best possible care for the patient today and in the future.

1 Lojer Capre E tables

This document gives instructions for operating and maintaining the device. Please familiarize yourself with these instructions before using the device. Use the device only as described and for the specified applications. Store these instructions in an appropriate way, making sure that the instructions are available to all possible users throughout the life of the device.



To avoid injury, follow the instructions given in this document



To ensure safe use and not invalidate your warranty, use the product only as described in these instructions.

1.1 Intended purpose

Examination tables are intended for transient and short-term use to support a patient during medical examinations and minor procedures related to the examinations. The devices are intended to be used by the intended users in healthcare centers, hospitals or other medical facilities. The devices are not intended to be used in an operating theatre environment, nor in spaces with a very demanding hygiene level. The devices are not intended for home use.

1.2 User Groups

The Owner or Holder is any natural person who owns the product. The owner is responsible for the safe use of the product and is responsible for ensuring that the product is always used safely including maintenance, cleaning and disposal. It is the responsibility of the holder to ensure that all users, including staff, have received appropriate training in the use of the equipment and are familiar with the risks involved in using the equipment and the dangers of improper use.

The Intended User is a person who, by virtue of his education, experience or familiarity, is capable of operating the device, must be able to anticipate and identify risks associated with the use of the device and be able to assess the patient's clinical status and treatment risks. It is the user's responsibility to ensure that the treatment meets the requirements of all applicable local laws and regulations.

A Patient/ Client is a person in need of treatment or therapy given by a healthcare professional. Intended clinical benefits

Indications for examination are typically symptoms of a disease or sensation of pain. Lojer 4040X Examination Table provides a support for a patient when these symptoms are examined by health care professional. Lojer Capre E Examination tables have standard equipped paper holder to protect the lying surface and patient.

1.3 Contra-indications

The device has no contraindications.

1.4 Description of parts

The sections of Lojer Capre E examination tables are shown below.

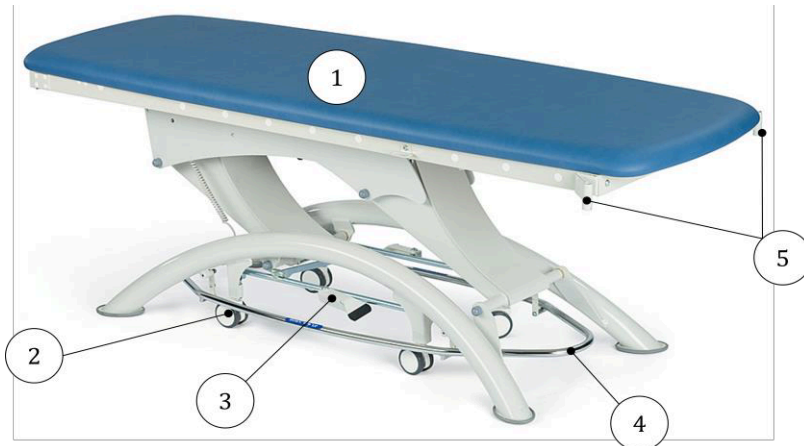

Figure 1: Lojer Capre E1 examination table

- 1 Lying surface
- 2 Castors (accessory)
- 3 Central locking pedal
- 4 Place free height adjustment bar (accessory)
- 5 IV-pole mounting adapter (accessory)



Figure 2: Lojer Capre E2 examination table













- 1 Back section
- 2 Leg section
- 3 IV-pole mounting adapter (accessory)
- 4 Castors (accessory)
- 5 Central locking pedal
- 6 Place free height adjustment bar (accessory)

1.5 Options and accessories

Options and accessories available for Lojer Capre E examination tables:

- Place free height adjustment bar (standard in FX-models)
- Castors
- IV-pole mounting adapter
- Paper roll holder
- Neck cushion
- Skai Clinica upholstery
- Calf supports (only for Capre EG)

1.6 Symbols used on the device

Symbol	Description
CE	The device is in conformity with essential requirements of the Directive 93/42/EEC (Medical devices)
IPX4	Protection against liquids
	Type B medical device
	Transformer is equipped with overheating protection.
	Indoor use only.
	Protectively isolated structure.
	Protective ground (Class I electric appliance)
	Double insulation (Class II electric appliance)
	Squeezing hazard (markings on the place free height adjustment bar or lower frame)
	Important/Warning
	Warning
	International patent
	CH01
	Fragile (package label)
	This side up (package label)



Store in a dry place (package label)

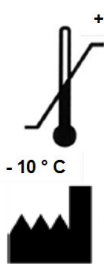

Temperature limits for transportation and storage

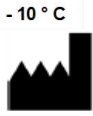

Manufacturer

2 Introduction

2.1 Inspection upon delivery

Before the device is taken into use, check that the packaging is intact and that it has not been damaged during transportation. Make sure that all packing materials have been removed. Please notify the transport company and the supplier of any transit damage within two (2) days of receiving the delivery.

Ensure that the delivery contains all the parts detailed in the delivery note. If there is anything missing from the delivery consignment, please contact the supplier immediately.



The device can be stored at a temperature of $-10 +50^{\circ}\text{C}$ and a permitted humidity range of 20...70%.

2.2 Before use

Device is meant to be used mainly in indoor conditions. If there is chance that device has been exposed to temperatures below 0°C , allow it to adjust to the indoor temperature for at least 5 hours before using any of its features. Make sure that the device can freely move up and down.

Familiarize yourself with the instructions and carry out the following before using the device:

- Make sure that all packing materials have been removed
- Make sure that the device can freely move up and down
- Place the device in the location where it will be used and lock the castors.
- Connect the power plug to a socket whose supply voltage corresponds to the voltage shown on the device's type plate. Make sure that the cord runs freely from the connection box.



Figure 3: Lifting points



Pay attention when lifting the chair. Do not lift the chair alone.

2.3 Leveling the table

If the floor is uneven, the table might tilt. This can be corrected with adjustment pad included in the delivery. Each tube has a slot into which the pad can be screwed to achieve desired height.



Figure 4: Levelling the table

2.4 Safety instructions



Estimate the patient's clinical state and risks of using the device (Danger of falling, trapping and suffocation).



Risk of falling and squeezing! When using mechanical adjustments of the device and its accessories, always make sure of proper locking of the adjustments by testing with hands.



Use the device according to the intended use defined by the manufacturer.



Make sure that the patient doesn't accidentally move/touch any control device.



Do not bind the power cord to the device as the lifting motion can damage the cord. Ensure that the cord is easily detachable in an emergency situation.



Make sure that the distance to the socket is not more than 2 meters.



If the power cord is damaged, unplug it immediately. Do not use the device and contact the service. Use only the original power cord.



Always detach the power cord before moving the device. Make sure that the cord doesn't get stuck between parts of the frame or under the castors.



Do not place the device under any wall structures or too close to the wall. Do not modify the structure of the device or install parts or accessories other than those mentioned in this document.



Make sure that the patient doesn't accidentally move/touch any control device.



Do not place anything under the device.



Only patient should be on the sitting surface when the device is adjusted.



Ensure that each locking mechanism functions properly.



Make sure that there is enough space around, above and below the device for the movements. Notice that the accessories increase the need for space.



Use the device according to the configurations, accessories and parts approved by the manufacturer.



Do not use the device or the accessory if it doesn't work properly. Contact the service.



Do not push the device on to a door sill.



WARNING! Children or people with no experience of the device or those with restricted understanding must not use the device. Children must be supervised to ensure that they do not play with the device! For safety reasons lock the device or unplug the power cord when the device is left unsupervised



WARNING! The safe working load (SWL) is the maximum load including the patient and possible accessories.

3 Using the device

Note! Do not use the electrical functions of the device non-stop for longer than the permissible two (2) minutes. Longer continuous use may cause the transformer to overheat. If you use electrical functions non-stop for two (2) minutes, keep to the operating time ratio and do not use any electrical functions for 18 minutes.

3.1 Adjustment range

Adjustment range of the Capre E tables is shown below:

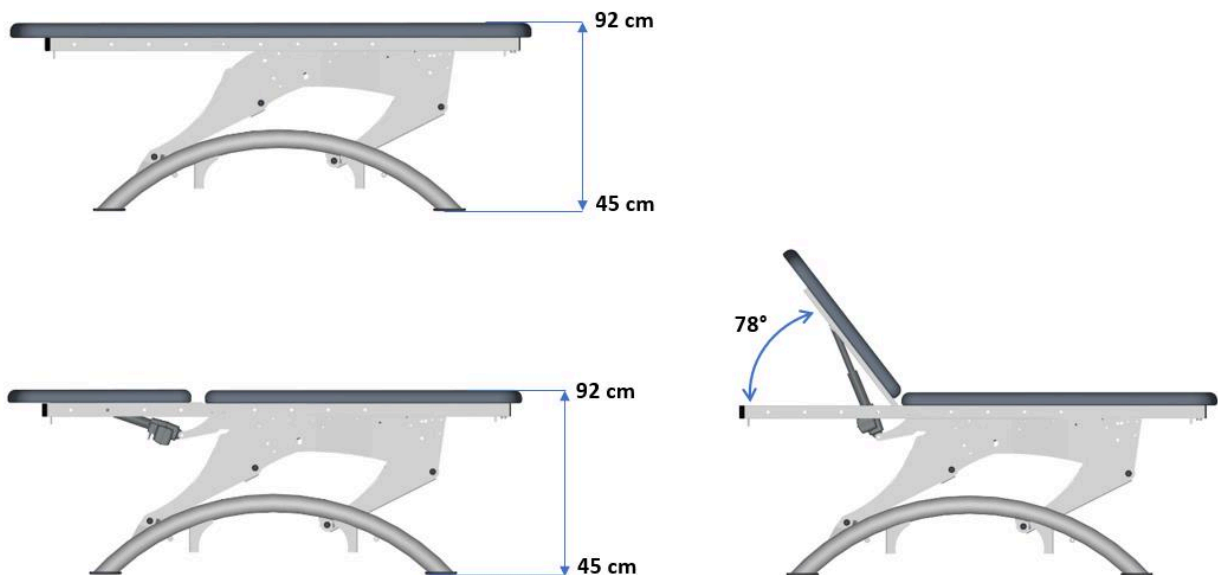

Figure 5: Adjustment range of the Lojer Capre E tables

3.2 Central locking

Castors with central locking are available as an option for Capre E examination tables. In order to free the locking, refract the pedal on either side of the table and press it down (**Error! Reference source not found.**). To set ready for use, release the pedal and refract it back to its position.



Figure 6: Central locking pedal



Always lock the castors before and after using the device. pay attention when unlocking castors on inclined floor.

3.3 Height adjustment

All electrical adjustments are stopped when the button/bar is released. In case of malfunction, use the control for opposite movement. The movements can also be stopped by unplugging the power cord.

The height of the table can be adjusted with foot control, hand control or place free height adjustment bar. The table top rises when you move the bar towards the head section of the table. The tabletop lowers when the bar is moved towards the leg section. The bar can be used from all sides of the table.



Figure 7: Foot operated height adjustments

Height can be adjusted also with the hand control. Push the button of the desired adjusting direction. Release the button in order to stop the movement.



Figure 8: Hand control height adjustment



Squeezing hazard! Operate the place free bar underneath. Do not push it down.



Ensure that there are no obstacles in the foot control range of movement. Squeezing hazard caused by accidental movement of the device!



The place free height adjustment bar moves sideways Do not place your entire weight on it.



Squeezing hazard! Before using/adjusting the device/ part/accessory ensure that nothing is or gets between the structures or under the device.



SQUEEZING HAZARD! Make sure that under any circumstances the patient doesn't accidentally move/touch any control device or the place free height adjustment bar. If necessary, use the safety switch.

Tables with place free height adjustment bar are equipped with safety switch which makes it possible to disconnect the power supply. Disconnecting is done by turning the pointer to the left (lock). Use the safety switch in order to make sure that the patient won't accidentally touch the control devices or when you leave the device without supervision.

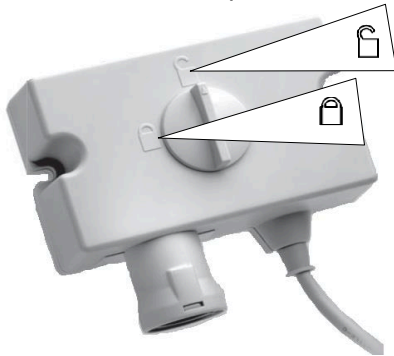

Figure 9: Safety switch

3.4 Back section

Capre E2 table has electric back section adjustment. Adjustment is done with hand control. Push the button of the desired adjusting direction. Release the button in order to stop the movement.



Figure 10: Hand control back section adjustment



SQUEEZING HAZARD! Make sure that under any circumstances the patient doesn't accidentally move/touch any control device or the place free height adjustment bar. If necessary use the safety switch.



SQUEEZING HAZARD! Make sure that nothing is or gets between the structure or under the device during lifting/lowering.

3.5 Options and accessories

3.5.1 Paper roll holder

The paper roll holder is located at the head end of the table. Two screws and nuts are supplied with the holder. Use the screws to fasten the holder to the cross beam at the head end of the table. The width of the paper roll holder is either 50 cm or 60 cm.



Figure 11: Paper roll holder



Do not use any accessory as a rise support

3.5.2 Battery operation

With battery operation the table can be adjusted without electrical power. The capacity of the battery is adequate for daily use. Charge the battery every day by plugging the power cord.



Battery is meant to be used only in emergency situations

Battery information:

Capacity: 1,2 Ah

Voltage: 24V

Charge time: 4-6h



SQUEEZING HAZARD! Use the safety switch when battery operated table is left without supervision or service is conducted.



Notice that the device with battery the electrical functions of the table work even when the power cord is unplugged. Use the locking function of the safety switch to ensure safety.



Always lock the table during transportation if table is equipped with battery.

3.5.3 IV-pole

Adapters for IV-pole are available as an option for all Capre examination table models. Adapters are located on the both sides of the table. Install the pole to the adapter and lock it by releasing the lever (2). Lift the release ring on the pole (3) to adjust the height. Release the ring to lock the pole on the suitable height.

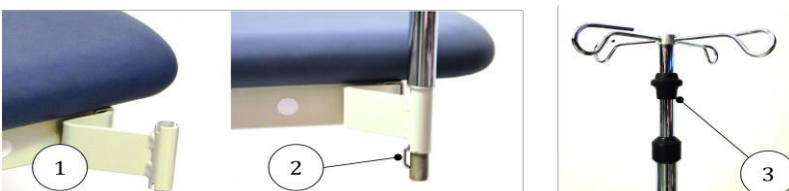

Figure 12: IV-pole and adapter

4 Cleaning and disinfecting



Before starting cleaning or servicing, make sure that the power cord is disconnected and that the device's functions have been locked. Check by testing the functions.



Devices equipped with a battery system can be adjusted even when the power cord is unplugged or during a power outage as long there is power in the batteries. The operations of the device may be prevented by using the locking feature.



Do not machine wash or use water spray for cleaning. Do not clean in high temperature or air humidity by using e.g. steam or hot water.



All surfaces must be allowed to dry after cleaning or disinfecting before using the device or its accessories.



Clean the product as instructed before use.



Do not use any unsuitable cleaners or disinfectants for cleaning and disinfecting the device. See the instructions below. Follow the respective manufacturer's instructions.



Allow the surface of electrical components to cool off before carrying out maintenance or cleaning procedures.



Avoid moisture entering the connection points. Excessive moisture can cause liquid pooling and damage the device.



Avoid contact with non-colorfast materials (e.g. jeans or other textiles). This kind of discoloration is excluded from any guarantee.

4.1 Cleaning

Clean the device aseptically following the work order: From top to bottom and from cleanest to dirtiest. Take into account the following things when cleaning the device:

- The device cannot be machine washed.
- Clean stains and visible dirt as soon as possible.
 - ➔ Blood and secretion stains should be removed immediately after they appear.
 - ➔ Some substances used in care work may cause permanent stains.
- Make sure that the power cord is disconnected and that the device's functions have been locked.
- To guarantee successful cleaning, if necessary, remove the accessories of the device.
 - ➔ Remember to clean the accessories before reattaching or storing them.
- The surfaces should always be cleaned before disinfection.
 - ➔ Follow the cleaning instructions given by the detergent manufacturers.
- In order to keep the surfaces in good condition, clean the device regularly.
 - ➔ Always clean the device between patients.
 - ➔ Take into consideration facility-specific cleaning and disinfecting instructions when cleaning the device.
- Any surface should not be subject to long-term exposure by any type of liquids.

4.1.1 Frame and other hard surfaces

- Clean all surfaces with a damp (micro)fiber cloth and a mild detergent solution (neutral pH 6–8 or weakly alkaline pH 8–10). Pay special attention to thorough cleaning of contact surfaces.
 - ➔ Do not use e.g. any solvents, abrasive cleanings agents or scouring pads as they can damage the surfaces.
- Use a soft brush to clean difficult stains, corners and other hard to reach places.
- Remove detergent residues or excess detergent by wiping the surfaces with a cloth dampened with clean water (follow the respective detergent manufacturer's instructions).
- Allow the surfaces to fully dry before using or storing the device.

4.1.2 Textile surfaces

- Clean all surfaces with a damp (micro)fiber cloth and a neutral detergent solution (pH 6–8).
 - ➔ Do not use e.g. any solvents, abrasive cleanings agents or scouring pads as they can damage the surfaces.
- Use a soft brush to clean difficult stains, corners and other hard to reach places.
- Remove detergent residues or excess detergent by wiping the surfaces with a cloth dampened with clean water (follow the respective detergent manufacturer's instructions).
- Dry the surfaces carefully after cleaning and ensure that they are fully dry before using or storing the device.

4.2 Disinfecting







The surfaces should always be cleaned before disinfection. Use disinfectant only if justified (e.g. to prevent the transmission of harmful microbes) as disinfection agents might change the surface structure of materials over time.

- Blood and urine stains should be removed immediately after they appear.
- Follow the disinfecting instructions given by the disinfectant manufacturers.
- Any surface should not be subject to long-term exposure by any type of liquids.

4.2.1 All surfaces

- Disinfect the surfaces with a damp (micro)fiber cloth, using disinfectants suitable for disinfecting medical devices, in accordance with the respective manufacturer's intended purpose and instructions for use.
 - ➔ For example, peroxygen or chlorine-based substances can be used to clean and disinfect secretion stains.
 - ➔ Clean and disinfect the device's castors when they have been visibly contaminated.
- Allow the surfaces to fully dry before using or storing the device.

5 Maintenance



-  Read the instructions carefully.
-  Only trained and manufacturer authorized person may carry out service and repair. Maintenance carried out by an unauthorized person may cause injury or damage to the device which the manufacturer is not responsible for.
-  Use only original spare parts approved by the manufacturer.
-  Make sure that the device is operating correctly after all maintenance measures.
-  Do not use the device or the accessory if it doesn't work properly.
-  All service and repair operations must be documented.

5.1 Biannual measures

The professional user is responsible for executing biannual measures. Check the condition and functioning of following parts at least every six months:

- Power cord and its fastening.
- The wiring of the motors.
- Controls and their wiring.
- The fastening of the accessories.
- Condition of gas springs
- The fastening and movement of the castors. Proper functioning of the central locking.
- Go through all adjustment and make sure that the table is working correctly.

Stop using the device if you notice any defects e.g. the device is making noise or functioning in sufficiently. Contact the service. Only authorized personnel can open or change the actuator/control unit.

-  If some part of the device is damaged, detach the power cord and stop using the device. Contact the service.
-  Make sure that the all parts are properly placed after any maintenance measures.

5.2 Annual measures

Check and lubricate the following parts once a year or more often if necessary.

- Joints
- Bearings
- Bearing points of the underside rods

Check all frame parts and joint to identify any fractures, rust or other damages.

5.3 Troubleshooting

Indication	Defect	Action
One of the actuators doesn't work	The wiring is damaged or loose	Check the fastening and the condition of the wirings.
	Defective control or place free height adjustment bar.	Check the control operation by testing with similar working control. Change the control if necessary. Contact the service.
	Defective actuator.	Contact the service.
	Defective control box.	Contact the service.
Any of the actuators don't work.	Defective control or place free height adjustment bar.	Check the control. Contact the service.
	No power.	Check that the power cord is properly plugged.
	Defective power cord.	Check the cord and contact service.
	Defective control box.	Contact the service.
Device is making noise.	The lubrication of the joints has worn out.	Lubricate the joints and actuator fastening points.
	The actuator is worn out or overloaded.	The actuator might stop working. Contact the service.

In order to change the actuators, controls or control box and ordering other spare parts contact the Lojer Service. Before contacting, find out the following information from the type plate of the device:

- Name, model and the serial number of the device
- Date of purchase
- Description of the problem

5.4 Preventive maintenance

The electrical characteristics and normal operation of the device should be performed according to the EN 62353 standard. In order to maintain the performance of the device, tests should be executed at least every 3 years. Electrical equipment should be inspected by an approved service technician or some other party approved for servicing medical devices.

EN 62353 applies to testing of medical electrical equipment during maintenance, inspection and servicing to assess the safety of the devices. Tests should be performed by qualified personnel. Qualification should include training, knowledge and experience with the relevant test procedures, technologies and regulations. The personnel assessing the safety should be able to recognize possible consequences and risks related to non-conforming devices.



Tests performed by non-qualified personnel might cause injury or damage to the device which the manufacturer is not responsible for.

<p>PROTECTIVE EARTH RESISTANCE</p>	<p>Test is performed only for Class I equipment. All accessible conductive parts should be included into test. Measurement current should be 200 mA. The total resistance should not exceed 0,3 Ω.</p> <p>Detachable power cords kept ready for use should be measures as well. Their resistance should not exceed 0,1 Ω.</p> <p>Before testing check the earth conductors and change them if necessary. Test is performed between the protective earth connector of the mains plug and protectively earthed accessible conductive part. The measured resistance should not exceed 0,2 Ω. Test both the potential equalization point and the frame.</p> <p>If the device is disassembled or the protective earth conductors have been changed, protective earth resistance should be measured from various points.</p>
<p>LEAKAGE CURRENTS</p>	<p>The measuring device should be appropriate for testing leakage currents.</p> <p>Detach the power cord of the medical device and connect it to the measuring device. Attach the protective earth measurement lead to the point under test (change points if necessary). Attach the applied parts to the measuring device. (Note! In Class I equipment a leakage current measurement can be performed only after the protective earth testing has been passed.)</p> <p>Use the correct measurement method and procedures related to that.</p> <p>Currents to be measured:</p> <p>Equipment leakage current (current from the mains part to earth through protective conductor and accessible parts and applied parts): Class I, type B applied part 500μA.</p> <p>Applied part leakage current (current from the mains part and the accessible parts to applied parts of the device): Class I, type B applied part 5000μA.</p>
<p>EVALUATION: The evaluation of safety of the tested equipment should be performed by electrically skilled person, who has the appropriate training for the equipment under test.</p>	
<p>FUNCTIONAL TEST</p>	<p>Perform the procedures mentioned in Section. Go through all functions in order to make sure that the device is working correctly. Stop using the device if you notice any defects e.g. the device is making noise or functioning in sufficiently. Contact the service.</p>
<p>REPORTING OF RESULTSTS</p>	<p>All test performed should be documented. The documentation should include at minimum the identification of the testing organization, name of the person who performed the tests, identification of the equipment, details of the tests, date and the result of the functional tests and measurements.</p>

6 Technical information

Check the information also from the type plate.

Operating voltage	230 V~50-60 Hz or 100 V~50-60 Hz or 120 V~50 -60Hz
Input power	230 W (VA)
Duty cycle	2 min on/18 min off
Ingress protection range	IP54
Electric classification	Class I, type B applied part
Safe working load	210 kg
Maximum patient weight	200 kg
Width	65 cm (80cm option)
Length	E1,2; 199 cm / EG; 197 cm
Transportation/Storage temp	-10...+50 °C,
humidity	20...90%
Operating temperature	+10...+40 °C
humidity	20...90%
UDI-DI	06430021930323 (Capre E1), 06430021930330 (Capre E1 AM), 06430021930347 (Capre E2), 06430021930354 (Capre E2 AM)

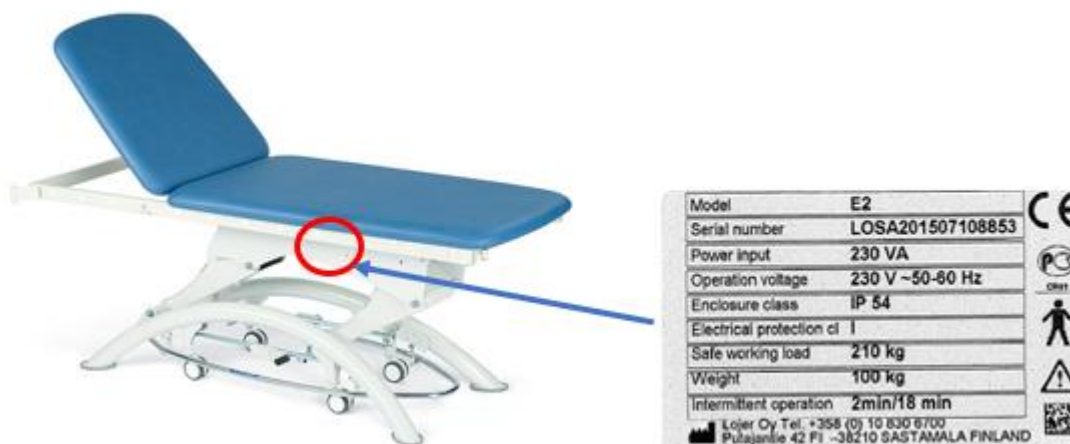

Figure 13: Type plate and its location

6.1 Standards

The device is in conformity with requirements of the EU Medical Device Regulation 2017/745. The device is marked with CE marking. The device is classified as Class I medical device.

6.2 Recycling

Most of the materials used in the device are recyclable. When the device is no longer usable, it should be disassembled and recycled properly. Recycling should be done by a specialist company, and parts of the equipment should not be disposed of with unsorted landfill waste.

Pre-treatment and storage

If the device has a battery, it should be removed after use (Note: Also remove the hand controller batteries). Oils must be removed from the hydraulic system and dispose these oils in an appropriate waste processing plant.

The gas spring must be depressurized and the oils removed before being collected to metal waste.

Disassembly of the product into components

Disassemble the product into components, and sort different materials before recycling:

METAL WASTE: frame, screws, nails, hinges, springs, etc.

ENERGY WASTE (combustible waste): solid wood and other wood-based materials, particle board, etc., which are not forbidden to burn (PVC must not be disposed of by burning, because the burning process produces highly toxic fumes).

SER WASTE (electrical and electronic waste): hand controller, all wires, motors, etc.

MIXED WASTE: plastic parts (wheels), upholstery and other parts where materials cannot be separated.

PVC waste is sent separately to a waste center or to a sorting station. PVC plastic is known from the sign below, material number 03.



The pre-treated and sorted materials are delivered to special collection points. Always follow regional and collection point specific instructions. Recycling can significantly reduce soil waste.

6.3 Circuit diagram

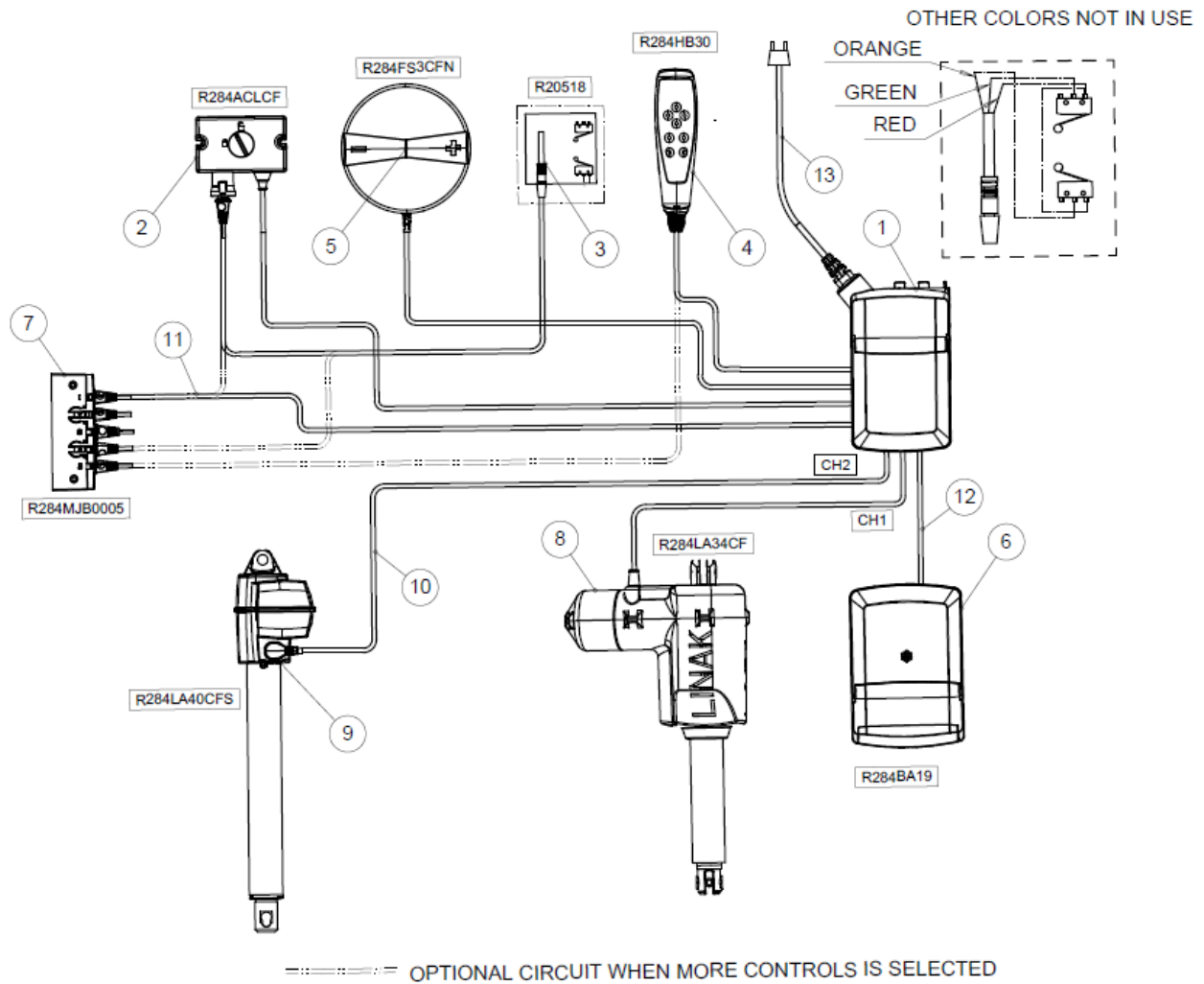

Figure 14: Circuit diagram of the Capre E tables



Nro	Name	M	F	Code	
1	Control box	o	o	R284CA30	✓
2	Safety switch (related to place free height adjustment bar)	o	o	R284ACLCF	✓
3	Switch box (related to place free height adjustment bar)	o	o	R20518	✓
4	Hand control	x	o	R284HB30	✓
5	Foot control	o	x	R284FS3CFN	
6	Battery	x	x	R284BA19	✓
7	Adapter MHB	o	o	R284MJB0005	✓

8	Lifting actuator	o	o	R284LA34CF	✓
9	Back section actuator (E2)	-	x	R284LA40CFS	✓
10	Actuator cable LA40 >CA30 (E2)	o	o	R284LA40-CA30	✓
11	Spiral cable MJB -> ACL	x	x	R284MJB-ACL	✓
12	Battery Cable	x	x	R2841019W	✓
13	Power cord	o	o	R284CAB90022 (230V) R284SLM912261 (230V GROUNDED) R284CAB90032 (120V) R284CAB90033 (120 V GROUNDED)	

6.4 Electromagnetic compatibility (EMC)

Other devices may interference even a slightly standard guidelines exceeding electromagnetic radiation values. To check, if this device is causing interference, stop use of this device by disconnecting it from mains and check if it will make difference in other equipment. If malfunction in other device ends, this device may cause noticed problems. This rare and unusual behavior can be reduced or eliminated by following methods:

- Change position, distance or relocate compared to another equipment.
- Ensure that used devices are suitable for existing environment.

	Use of this equipment adjacent to or stacked with other equipment should be avoided because it could result in improper operation. If such use is necessary, this equipment and the other equipment should be observed to verify that they are operating normally
	Portable RF communications equipment (including peripherals such as antenna cables and external antennas) should be used no closer than 30 cm (12 inches) to any part of the device, including cables specified by the manufacturer. Otherwise, degradation of the performance of this equipment could result.
	Use of accessories, transducers and cables other than those specified or provided by the manufacturer of this equipment could result in increased electromagnetic emissions or decreased electromagnetic immunity of this equipment and result in improper operation.

6.4.1 Electromagnetic emission

Medical device (Lojer 4040XL) is intended for use in the electromagnetic environment specified below. The customer or the user of the medical device should assure that it is used in such an environment. Portable devices which are using radiofrequency can affect use of this equipment.

Guidance and manufacturer's declaration – electromagnetic emissions		
Emissions test	Compliance	Electromagnetic environment-guidance
RF emissions CISPR 11	Group 1, class B	Medical device uses RF energy only for its internal function. Therefore, its RF emissions are very low and are not likely to cause any interference in nearby electronic equipment.
Harmonic emissions IEC	Class A	Device is directly connected to the public low-voltage

61000-3-2		power supply network that supplies buildings used for domestic purposes.
Voltage fluctuations/ flicker emissions IEC 61000-3-3	Complies	

6.4.2 Electromagnetic immunity

This product is intended for use in electromagnetic environments that are specified below. The user should ensure that the product is used in an appropriate environment.

Immunity test	IEC 60601 test level	Compliance level	Electromagnetic environment-guidance
Electrostatic discharge (ESD) IEC 61000-4-2	±8 kV contact ±2 kV, ±4 kV, ±8 kV, 15 kV air	±8 kV contact ±2 kV, ±4 kV, ±8 kV, 15 kV air	Floors should be wood, concrete or ceramic tile. If floors are covered with synthetic material, the relative humidity should be at least 30%.
Electrical fast transient/burst IEC 61000-4-4	±2 kV for power supply lines; 100 kHz frequency ±1 kV for input/output lines; 100 kHz frequency	±2 kV for power supply lines; 100 kHz frequency ±1 kV for input/output lines; 100 kHz frequency	Mains power quality should be at levels characteristic of a typical location in a typical commercial or hospital environment.
Surge IEC 61000-4-5	±1 kV (line to line) ±2 kV (line to earth)	±1 kV (line to line) ±2 kV (line to earth)	Mains power quality should be at levels characteristic of a typical location in a typical commercial or hospital environment.
Voltage dips, short interruptions and voltage variations on power supply lines IEC 61000-4-11	< 0% U(T) for 0,5 cycle at 45° phase angles 0% U(T) for 1 cycle at 0° 70% U(T) for 25/30 cycles at 0° < 5% U(T) for 250/300 cycles at 0°	< 0% U(T) for 0,5 cycle at 45° phase angles 0% U(T) for 1 cycle at 0° 70% U(T) for 25/30 cycles at 0° < 5% U(T) for 250/300 cycles at 0°	Mains power quality should be at levels characteristic of a typical location in a typical commercial or hospital environment. If uninterrupted use during power failure is required, the device should be equipped with battery. U(T) is the (AC) mains voltage before the testing level is applied.
Magnetic field at supply frequency (50/60 Hz) IEC 61000-4-8	30 A/m	30 A/m	Magnetic fields at mains frequency should corresponds to the typical values present in commercial and hospital environment.

Conducted radio frequency IEC 61000-4-6	3V 150 kHz - 80 Mhz 6V ISM frequency range 3 V/m 80 Mhz - 2,7 Ghz	3V 150 kHz - 80 Mhz 6V ISM frequency range 3 V/m 80 Mhz - 2,7 Ghz	Portable and mobile RF communications equipment should not be used closer to any part of the medical device, including cables, than the recommended distances calculated from the equation applicable to the frequency of the transmitter. Recommended separation distance $d=1.2\sqrt{P}$ $d=1.2\sqrt{P}$ 80MHz to 800MHz $d=2.3\sqrt{P}$ 800MHz to 2700 MHz Where P is the maximum output power rating of the transmitter in watts (W) according to the transmitter manufacturer and d is the recommended separation distance in meters (m). Field strengths from fixed RF transmitters, as determined by an electromagnetic survey a, should be less than the compliance level in each frequency range. Interference may occur in the vicinity of equipment marked with the following symbol: 
Radiated radio frequency IEC 61000-4-3	385 Mhz – 5785 Mhz test definitions related to immunity to wireless communication devices using radio frequency (reference: Table 9, IEC 60601-	385 Mhz – 5785 Mhz test definitions related to immunity to wireless communication devices using radio frequency (reference: Table 9, IEC 60601-1-2:2014)	

Recommended separation distances between portable and mobile communication equipment and the medical device			
The medical device is intended for use in an electromagnetic environment in which radiated RF disturbances are controlled. The customer or the user of the medical device can help prevent electromagnetic interference by maintaining a minimum distance between portable and mobile RF communication equipment (transmitters) and the medical device as recommended below, according to the maximum output power of the communications equipment.			
Rated maximum output power of transmitter W	Separation distance according to frequency of transmitter (m)		
	150kHz to 80MHz $d=1.2\sqrt{P}$	80MHz to 800MHz $d=1.2\sqrt{P}$	800MHz to 2.7GHz $d=2.3\sqrt{P}$
0.01	0.12	0.12	0.23
0.1	0.38	0.38	0.73
1.0	1.2	1.2	2.3
10	3.8	3.8	7.3
100	12	12	23
For transmitter rated at a maximum output power not listed above, the recommended separation distance d in meters (m) can be estimated using the equation applicable to the frequency of the transmitter, where P is the maximum output power of the transmitter in watts (W) according to the transmitter manufacturer. Note 1. At 80MHz and 800MHz the higher frequency range applies. Note 2. These guidelines may not apply in all situations. Electromagnetic propagation is affected by absorption and reflection from structures, objects and people.			

7 Limited International Warranty

The terms of the warranty for the product are set out in the contract documents of the purchase. Unless otherwise agreed, the general warranty terms apply (see www.lojer.com or contact our service service@lojer.com).

8 Contact information

Manufacturer

Lojer Oy

Putajantie 42

FI-38210 Sastamala

Tel.. +35810 830 6700

Email: firstname.lastname@lojer.com

info@lojer.com

www.lojer.com

Copyright © Lojer Oy, 2023 | 2/20203

Service

Tel. +35810 830 6750

Email: service@lojer.com

Your local Lojer dealer, see www.lojer.com/distributors

Model: _____

Serial number: _____

Date of purchase: _____

Your local Lojer dealer: _____